

EL[®]MARK

The Brand of Electricity

BELLA LUMINAIRE SMD



GENERAL INFORMATION »

- ∴ Rated voltage: 230V/ 50-60Hz
- ∴ Power: 20W; 40W; 55W
- ∴ Colour temperature: 4000-4300K; 6300-6500K
- ∴ LED source: Epistar
- ∴ LED type: SMD2835
- ∴ Body: polycarbonate (PC), grey
- ∴ Diffuser: polycarbonate (PC), Opal cover
- ∴ Reflector: Steel white
- ∴ Colour rendering index: Ra≥80
- ∴ Switch on/off: 20 000
- ∴ Protection against mechanical impacts: IK08
- ∴ Protection against dust and moisture: IP65
- ∴ Available in variant with an emergency kit
- ∴ Working temperature: -20 to +40 °C



FEATURES »

- ∴ Replacement of conventional fluorescent tubes with highly efficient LED strip
- ∴ Installation options: surface ceiling mounting
- ∴ Low power consumption
- ∴ Repeated switch-on/off does not affect the lifespan of the luminaire
- ∴ Instant light with maximum luminous flux
- ∴ No ultraviolet and infrared rays
- ∴ Stable and functional light distribution

AREAS OF APPLICATION »

- ∴ Damp areas
- ∴ Dusty environment
- ∴ Kitchen premises
- ∴ Roofed outdoor areas

PRODUCT DETAILS »

Catalogue number	Catalogue number with Emergency kit	Watt (W)	Whole fixture lumens (lm)	Colour temp. (K)	Colour body
9BR20LED	-	20	1800	4000	grey
9BR20LEDCW	-	20	1800	6500	grey
9BR40LED	9BR40LEDE	40	3800	4000	grey
9BR40LEDCW	9BR40LEDCWE	40	43800	6500	grey
9BR55LED	9BR55LEDE	55	5000	4000	grey
9BR55LEDCW	9BR55LEDCWE	55	5000	6500	grey

DIMENSIONS »

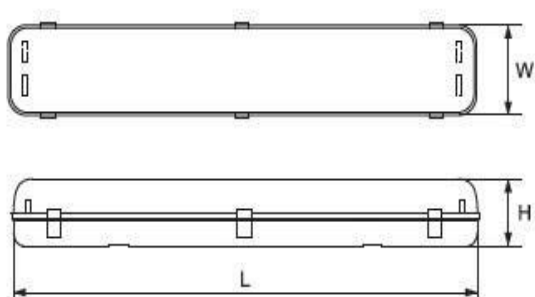

Model	Length	Width	Height
9BR20LED	600	80	70
9BR20LEDCW	600	80	70
9BR40LED	1200	80	70
9BR40LEDCW	1200	80	70
9BR55LED	1476	80	70
9BR55LEDCW	1476	80	70

LED EMERGENCY KIT SPECIFICATIONS »



General information »

- ∴ Voltage: AC85-265V 50Hz
- ∴ Emergency Output: 3-40W
- ∴ Emergency Time: > 2hrs (120mins)
- ∴ Battery: 3.7V 2400mAh
- ∴ Emergency Switching Time: <2s
- ∴ AC Fuse: 250V 1A
- ∴ DC Fuse: 250V 5A
- ∴ Luminous Flux: >100lm
- ∴ Light Source: LED
- ∴ Working temperature: -10°C +55°C
- ∴ IP Rate: IP30

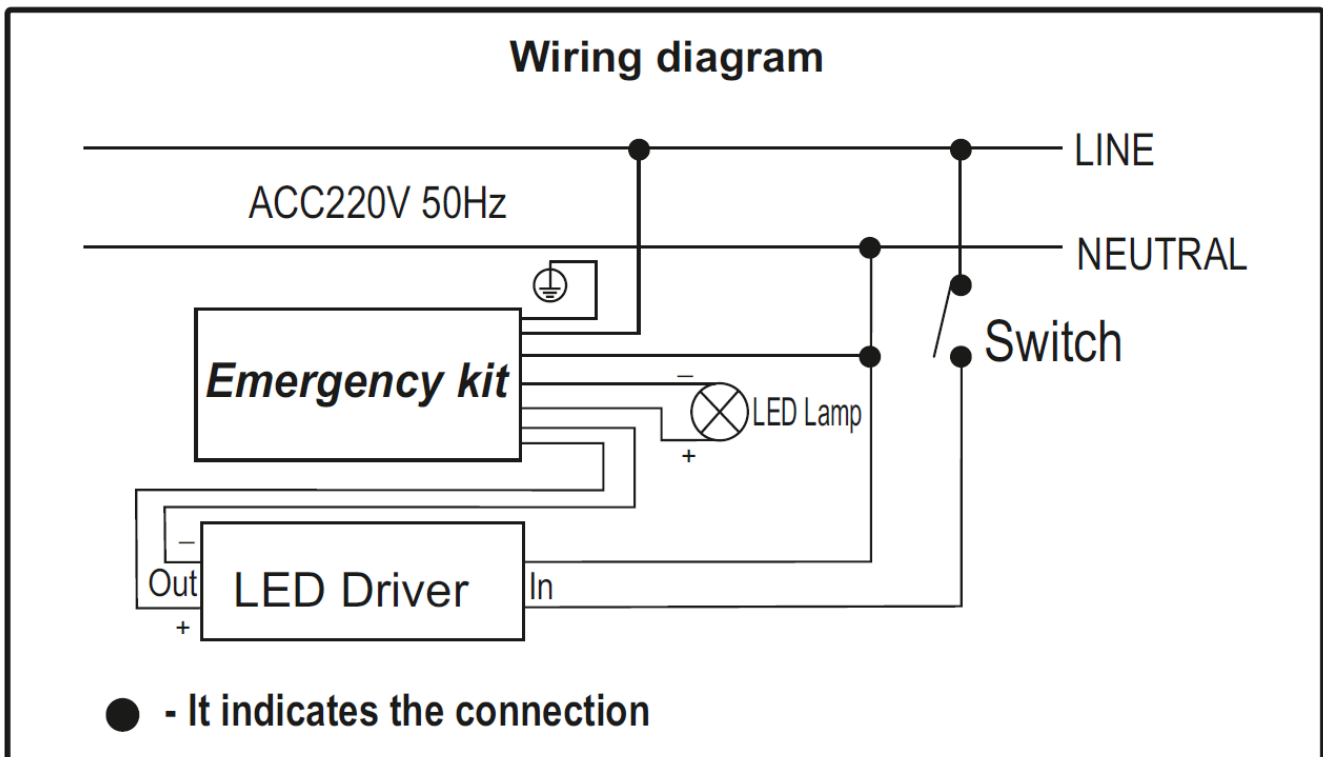
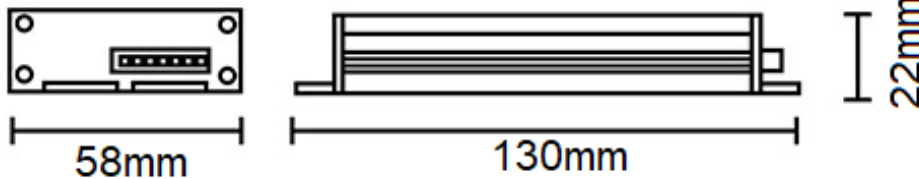

● - It indicates the connection

● Red = Charging ● Blue = Emergency ● Green = Power

ADDITIONAL INFORMATION »

9BR20LED



This luminaire contains built-in LED lamps.



L
E
D

The lamps cannot be changed in the luminaire.

874/2012

Catalogue number	Barcode	Packing/Box (pcs)
9BR20LED	3800131192417	1/16
9BR20LEDCW	3800131217950	1/16
9BR40LED	3800131192424	1/12
9BR40LEDCW	3800131210630	1/12
9BR55LED	3800131192431	1/9
9BR55LEDCW	3800131210647	1/9

