

ELMARK[®]
The Brand of Electricity

Owner's Manual & Safety Instructions

Multi Tool



⚠ WARNING

Read this manual before using this product.
Failure to do so can result in serious injury.
SAVE THIS MANUAL.



DESCRIPTION OF THE TOOL

OPERATING CONTROL



Read, understand and follow all safety rules and instructions before using this tool. Please keep this manual for future reference.

1. MAIN PARTS

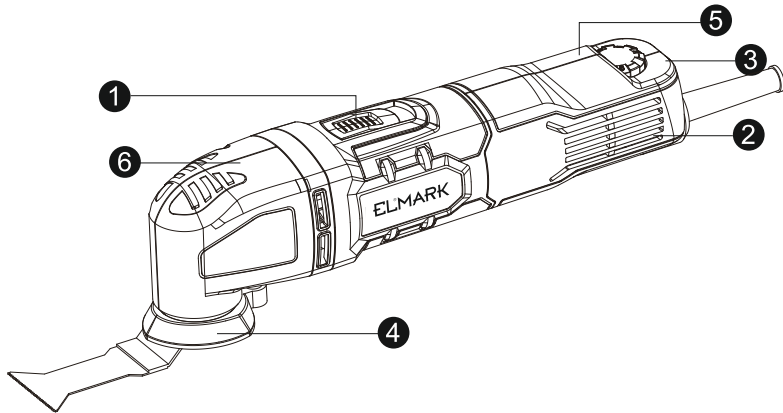

1. On/Off switch
2. Ventilation slots
3. Variable speed
4. Tool holder
5. Handle
6. Quick-fit wrench (86226)

2. TOOL SPECIFICATIONS

Model	59540
Rated voltage(V)	220-240
Frequency(Hz)	50/60
Input power(W)	280
No load speed(min ⁻¹)	11000-21000
Oscilations angle	3°
Protect Grade	□/II
Insulated Grade	E

Note1:

Due to ELMARK's continuing program of development, the specifications herein are subject of change, without prior notice.

Note2:

The values given are valid for normal vottages[U] of 220V. For lower or higher voltages and models for specific countries these values can vary.

GENERAL SAFETY RULES

⚠ WARNING: Read all instructions. Failure to follow all instructions listed below may result in electric shock, fire and/or serious personal injury. The term "power tool" in all of the warnings listed below refers to your mains operated (corded) power tool or battery operated (cordless) power tool.

SAVE THESE INSTRUCTIONS

1.WORK AREA

- 1) **Keep your work area clean and well lit.** Cluttered or dark areas invite accidents
- 2) **Do not operate power tools in explosive atmosphere, such as in the presence of flammable liquids, gases, or dust.** Power tools create sparks, which may ignite the dust or fumes.
- 3) **Keep children and bystanders away while operating a power tool.** Distractions may cause you to lose control.

2.ELECTRICAL SAFETY

- 1) **Power tool plugs must match the outlet. Never modify the plug in any way. Do not use any adapter plugs with grounded power.** Unmodified plugs and matching outlets will reduce the risk of electric shock.
- 2) **Avoid body contact with grounded surfaces, such as pipes, radiators, ranges, and refrigerators.** There is an increased risk of electric shock if your body is grounded.
- 3) **Do not expose power tools to rain or wet**

conditions. Water entering a power tool will increase the risk of electric shock.

- 4) **Do not abuse the cord. Never use the cord for carrying, pulling, or unplugging the power tool. Keep the cord away from heat, oil, sharp edge, or moving parts.** Damaged or entangled cords increase the risk of electric shock.

- 5) **When operating a power tool outdoors, use an extension cord suitable for outdoor use.** Use of a cord suitable for outdoor use reduces the risk of electric shock.

- 6) If operating a power tool in a damp location is unavoidable, use a residual current device (RCD) protected supply. Use of an RCD reduces the risk of electric shock.

3.PERSONAL SAFETY

- 1) **Stay alert, watch what you are doing and use common sense when operating a power tool. Do not use a power tool while tired or under the influence of drugs, alcohol, or medication.** A moment of inattention while operating power tools may result in serious personal injury.

- 2) **Use safety equipment. Always wear eye protection.** Safety equipment, such as dust mask, non-skid safety shoes, hard hat, and hearing protection, when used for appropriate conditions, will reduce personal injuries.

- 3) **Avoid accidental starting. Make sure that the switch is in the "OFF" position before plugging the tool into an electrical outlet.** Carrying power tools with your finger on the switch or plugging in power tools that have the power switch "ON" invites accidents.

- 4) **Remove any adjusting key or wrench before turning the power tool on.** A wrench or key left attached to a rotating part of the power tool may result in

personal injury.

5) **Do not overreach. Keep proper footing and balance at all times.** This enables better control of the power tool in unexpected situations.

6) **Dress properly. Do not wear loose clothing or jewelry. Keep your clothing, gloves, and hairs away from moving parts.** Loose clothes, jewelry, or long hair can be caught in moving parts.

7) **If devices are provided for the connection of dust extraction and collection facilities, make sure that these are connected and properly used.** Use of these devices can reduce dust-related hazards.

8) **Use clamps or another practical way to support and secure the workpiece to a stable platform.** Holding the work by hand or against your body leaves it unstable and may lead to loss of control.

9) **Do not use on a ladder or unstable support.** Stable footing on a solid surface enables better control of the power tool in Page 9 unexpected situations.

10) **Keep handles dry, clean, and free from oil and grease.** Slippery hands cannot safely control the power tool.

11) **Always wear safety glasses with side shields.** Everyday glasses may have impact resistant lenses, but they are not safety glasses. Following this rule will reduce the risk of eye injury.

12) **Protect your lungs.** Wear a face or dust mask if the operation is dusty. Following this rule will reduce the risk of serious personal injury.

13) **Protect your hearing.** Wear hearing protection during extended periods of operation. Following this rule will reduce the risk of serious person injury.

4. POWER TOOL USE AND CARE

1) **Do not force the power tool. Use the correct power tool for your application.** The correct power tool will do the job better and more safely at the rate for which it was designated.

2) **Do not use the power tool if the switch does not turn it ON and OFF.** Any power tool that cannot be controlled with the switch is dangerous and must be repaired.

3) **Disconnect the plug from the power source and/or the battery pack from the power tool before making any adjustments, changing accessories, or storing power tools.** Such preventive safety measures reduce the risk of starting the power tool accidentally.

4) **Store idle power tools out of the reach of children and do not allow persons unfamiliar with the power tool or these instructions to operate the power tool.** Power tools are dangerous in the hands of untrained users.

5) **Maintain power tools. Check for misalignment or binding of moving parts, breakage of parts and any other condition that may affect the power tool's operation. If damaged, have the power tool repaired before use.** Many accidents are caused by poorly maintained power tools.

6) **Keep cutting tools sharp and clean.** Properly maintained cutting tools with sharp cutting edges are less likely to bind and are easier to control.

7) **Use the power tool in accordance with these instructions and in the manner intended for the particular type of power tool, taking into account the**

working conditions and the work to be performed. Use of the power tool for operations different from those intended could result in a hazardous situation.

8) **Save these instructions.** Refer to them frequently and use them to instruct others who may use this tool. If you lend this tool to someone else, also lend them these instructions.

5. SERVICE

1) Have your power tool serviced by a qualified repair person.

2) When servicing a power tool, use only identical replacement parts.

3) Follow instructions in the Maintenance section of this manual. Use of unauthorized parts or failure to follow Maintenance instructions may create a risk of shock or injury.

ALL OF SAFETY RULES

1. Read all safety warnings, instructions, illustrations and specifications provided with this power tool. Failure to follow all instructions listed below may result in electric shock, fire and/or serious injury.

2. Do not recommend use this power tool operations as sander, wire brush and so on. Used this power tool do besides appointed function will cause hazards and personal injuries.

3. Do not use accessories which are not specifically designed and recommended by the tool manufacturer. Just because the accessory can be attached to your power tool, it does not assure safe operation.

4. The rated speed of the accessory must be at least equal to the maximum speed marked on the power tool. Accessories running faster than their rated speed can fly apart.

5. The outside diameter and the thickness of your accessory must be within the capacity rating of your power tool. Incorrectly sized accessories cannot be adequately guarded or controlled.

6. The arbor size of wheels, flanges, backing pads or any other accessory must properly fit the spindle of the power tool. Accessories with arbor holes that do not match the mounting hardware of the power tool will run out of balance, vibrate excessively and may cause loss of control.

7. Do not use a damaged accessory. Before each use inspect the accessory such as abrasive wheels for chips and cracks, backing pads for cracks, tear or excessive wear. If the power tool or accessory is dropped, inspect for damage or install an undamaged accessory. After inspecting and installing an accessory, position yourself and bystanders away from the plane of the rotating accessory and run the power tool at maximum no-load speed for one minute. Damaged accessories will normally break apart during this test time.

8. Wear personal protective equipment. Depending on application, use face shield, safety goggles or safety glasses. As appropriate, wear dust mask, hearing

protectors, gloves and shop apron capable of stopping small abrasive or work piece fragments. The eye protection must be capable of stopping flying debris generated by various operations. The dust mask or respirator must be capable of filtering particles generated by your operation. Prolonged exposure to high intensity noise may cause hearing loss.

9. Keep bystanders a safe distance away from work area. Anyone entering the work area must wear personal protective equipment. Fragments of the work piece or of a broken accessory may fly away and cause injury beyond the immediate area of operation. Contact with "live" wire will also make exposed metal parts of the power tool "live" and shock the operator.

10. Hold the power tool only by the insulated gripping surfaces when performing an operation where the cutting tool may contact hidden wiring or its own power cord. Contact with a "live" wire will also make exposed metal parts of the power tool "live" and shock the operator.

11. Position the cord clear of the spinning accessory. If you lose control, the cord may be cut or snagged and your hand or arm may be pulled into the spinning accessory.

12. Never lay the power tool down until the accessory has come to a complete stop. The spinning accessory may grab the surface and pull the power tool out of your control.

13. Do not run the power tool while carrying it at your side. Accidental contact with the spinning accessory could snag your clothing, pulling the accessory into your body.

14. Regularly clean the air vents of the power tool. The fan of the motor will draw dust inside the housing and excessive accumulation of powdered metal may cause electrical hazards.

15. Do not operate the power tool near flammable materials. Sparks could ignite these materials.

16. Do not use accessories that require coolants. Using water or other coolants may result in electric cauterization or electric shock.

avoided by taking proper precautions as given below.

1. Maintain a firm grip with your hands on the power tool and position your body and arm to allow you to resist kickback forces. Always use the auxiliary handle, for maximum control over kick-back or torque reaction during start-up. The operator can control torque reactions or kick back forces, if proper precautions are taken.

2. Never place your hand near the rotating accessory. The accessory may kickback over your hand.

3. Do not position your body in the area where the power tool will move if kickback occurs. Kickback will propel the tool in the direction opposite to the wheel's movement at the point of snagging.

4. Use special care when working sharp edges, sharp sides etc. Avoid bouncing and snagging the accessory. Sharp edges, Sharp sides or bouncing have a tendency to snag the rotating accessory and cause loss of control or kickback.

5. Do not attach a saw chain, woodcarving blade or toothed saw blade. Such blades create frequent kickback and loss of control.

ADDITIONAL SAFETY WARNING:

 Kickback and related warnings:

Kickback is a sudden reaction to a pinched or snagged rotating wheel, backing pad, brush or any other accessory. Pinching or snagging causes rapid stalling of the rotating accessory which in turn causes the uncontrolled power tool to be forced in the direction opposite of the accessory's rotation at the point of the binding. For example, if an abrasive wheel is snagged or pinched by the work piece, the edge of the wheel that is entering into the pinch point can dig into the surface of the material causing the wheel to climb out or kick out. The wheel may either jump toward or away from the operator, depending on the direction of the wheel's movement at the point of pinching. Abrasive wheels may also break under these conditions.

Kickback is the result of power tool misuse and/or incorrect operating procedures or conditions and can be

ADDITIONAL SAFETY RULES FOR MULTI TOOL

1. Keep hands away from cutting area and blade. Keep your second hand on auxiliary handle or motor housing. If both hands are holding the saw, they cannot be cut by the Original instructions blade.
2. Only use the power tool for dry sanding. Water entering a power tool will increase the risk of electric shock.
3. Keep hands away from the sawing area. Do not reach under the workpiece. Contact with the saw blade can lead to injuries.
- d. When ripping always use a rip fence or straight edge guide. This improves the accuracy of cut and reduces the chance of blade binding.
4. When changing the application tool, wear protective gloves. Application tools can become hot when used for prolonged periods of time.
5. Do not scrape any dampened materials (e.g. wallpaper) or on damp surfaces. Water entering a power tool increases the risk of electric shock.
6. Take particular care when handling scrapers and blades. The application tools are very sharp. Danger of injury.



WARNING: Some dust created by power Cutting contains chemicals known to cause cancer, birth defects or other reproductive harm. Some examples of these chemicals are:

- 1) lead from lead-based paints
- 2) Arsenics and chromium from chemically reacted lumber.

Your risk from these exposures varies, depending on how often you do this type of work. To reduce your exposure to these

chemicals: work in a well ventilated area, and work with approved safety equipment.

STANDARD ACCESSORIES

● Blade	1PC
● Scraper	1PC
● Sanding pad	1PC
● Sanding paper	2PCS
● Hex key wrench	1PC

Be sure to check the accessories as it is subject to change by areas and models.

OPERATION

WARNING: Before any work on the machine itself, keep the mains plug out of the supply.

Mounting/Replacing the tool

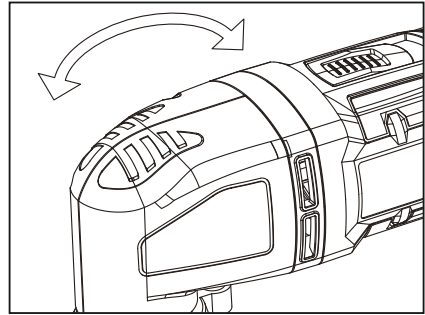

WARNING: Wear protective gloves when changing tools. There is a risk of injury when touching the application tools.

1. Set the quick-fit wrench to the maximum adjustment position.
2. Insert the replacement tool into the output shaft, adjust the tool to the appropriate position required for operation, and then align the hole in the tool with the cam of the tool.
3. Restore the quick-fit wrench to its original position.

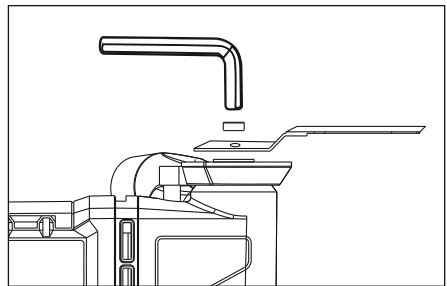

1. Open it with a hex wrench.
2. Put the blade.
3. Tighten it.

WARNING: Check that the application tool is seated securely. Application tools that are attached incorrectly or are not securely fixed in place may come loose during operation, thereby putting you at risk.

APPLICATIONS

1. POWER SUPPLY

The voltage of the power source must agree with the voltage specified on the nameplate of the machine.

2. Switch On/Off

 Make sure that the tool is closed before plugging in. To start the tool, slide the On/Off switch to the "0" position. To stop the tool, slide the On/Off switch to the "1" position.

3. Preselecting the orbital stroke rate

The required orbital stroke rate is adjustable and dependent on the material and the work conditions and can be determined using practical tests.

This tool is equipped with a "1-6" oscillation stage, the larger the number, the higher the oscillation frequency. Orbital stroke rate level "1-4" is recommended for sawing, cutting and sanding harder materials, such as wood or metal; orbital stroke rate level "5-6" is recommended for softer materials, such as plastic.

4. Sawing

Use only undamaged saw blades that are in perfect condition. Bent or dull saw blades can break, negatively influence the cut, or lead to kickback. Plunge cuts may only be applied to soft materials, such as wood, gypsum board, etc.

5. Cutting

 When cutting wall tiles, please bear in mind that the application tools are subject to high wear if used for extended periods.

6. Sanding

The material removal rate and sanding result are primarily determined by the choice of sanding sheet, the preselected orbital stroke rate level and the contact pressure. Only immaculate sanding sheets achieve good sanding performance and make the power tool last longer.

To sand corners, edges and hard-to-reach areas accurately, you can also work with the tips alone or with an edge of the sanding plate.

The sanding sheet may heat up significantly when used to sand specific points rather than entire surfaces. Reduce the orbital stroke rate and contact pressure and allow the sanding sheet to cool down at regular intervals.

7. Scraping

Select a high orbital stroke rate level for scraping. Work on a soft surface (e.g. wood) at a flat angle and with low contact pressure. Failure to do so may cause the scraper to cut into the surface underneath.

 While working, move the power tool back and forth to prevent the application tool overheating and jamming.

TOOL MAINTENANCE



WARNING: Before any work on the machine itself, the plug must be pulled out of power source.

1) Inspect the diamond cutting discs. The diamond cutting disc damaged or worn out will cause motor malfunction and affect the cutting efficiency, so suggest to replace the diamond cutting disc periodically.

2) Inspect tool cords periodically. The cord is special prepared, if damaged, have repaired at your nearest Authorized **ELMARK** Service Center. This tool was used with the power cord as a particular structure, don't replace the power cord without authorization, such as replacement, please go to the Authorized **ELMARK** Service Center.

3) Keep the vents clean. Clean all parts of the tool, clean dust periodically. To prevent debris from entry.

4) Replace the carbon brush when the carbon brush is worn out in certain length and motor stops running. All maintenance should be carried out by Authorized **ELMARK** Service Center.

5) All service MUST only be performed by Authorized **ELMARK** Service Center. ALWAYS use only **ELMARK** accessories that are recommended for this tool.

6) Cleaning. Avoid the use of plastic cracks caused by damage to the solvent. Use clean cloths and mild soap to remove dirt, dust, etc.

7) Avoid the tool vibration or impact, and keep it from oil and grease.

ENVIRONMENT PROTECTION

- 1.Tool, accessories and packaging should be sorted for environment-friendly recycling.
- 2.Power tools and accessories at the end of their service life still contain large amounts of valuable raw materials and plastics which can likewise be fed back into a recycling process.
- 3.Some dust created by working contains harmful chemicals must be collected by special garbage re- cycle site.

SERVICE

- 1.In case of guarantee, repair or purchase of replacement parts, always contact the qualified service center. And supplied with the efficient service card and invoice.
- 2.It is without the scope of guarantee when the tool was normal wear, overload or improper use of damage.

Trouble shooting

PROBLEMS	REASONS	WAYS TO SOLVE THE PROBLEMS
1. The motor stops running	1. Unconnected to power source	1. Connect to power source
	2. Plugs not fully connect	2. Check all plugs
	3. Switch out of work	3. Replace or repair the switch
	4. Brushes not touch the commutator	4. Replace the brushes with two new ones
2. Running slowly (Not running)with the noise at the beginning of power turn-on	1. Switch out of work	1. Replace or repair the switch
	2. Mechanical trouble	2. Check mechanical parts
3. Commutator sparkle	1. Armature short circuit	1. Repair the armature
	2. Poor connection between the brush and the commutator	2. Replace it with a new one
	3. Commutator surface not smooth	3. Clean the commutator surface

ELMARK[®]

www.elmarkholding.eu

ELMARK FACTORY IN EUROPE

ELMARK INDUSTRIES SC
BULGARIA, DOBRICH
2 Dobrudja Blvd.
Tel: +359 58 500 059 +359 58 500 050
Fax: +359 58 500 060
E-mail: elmarkfactory@elmarkholding.eu

GENERAL REPRESENTATIVE FOR BULGARIA

ElektroMarkeT LTD
GRUP
BULGARIA, VARNA
ZPZ, 10 Perla Str.
Tel.: +359 52 57 55 57
Fax: +359 52 57 55 80
E-mail: officevarna@elmarkgroup.eu